

INSPIRATION



THE TOWER AT TEMPLE CHURCH



THAI LANTERN

The inside of the tower remind me of the Thai lantern called "Kratong puang tow lung". I got the modular form from the individual shape of the lantern, and I looked at the sunpath as the lantern create a really nice shadows.

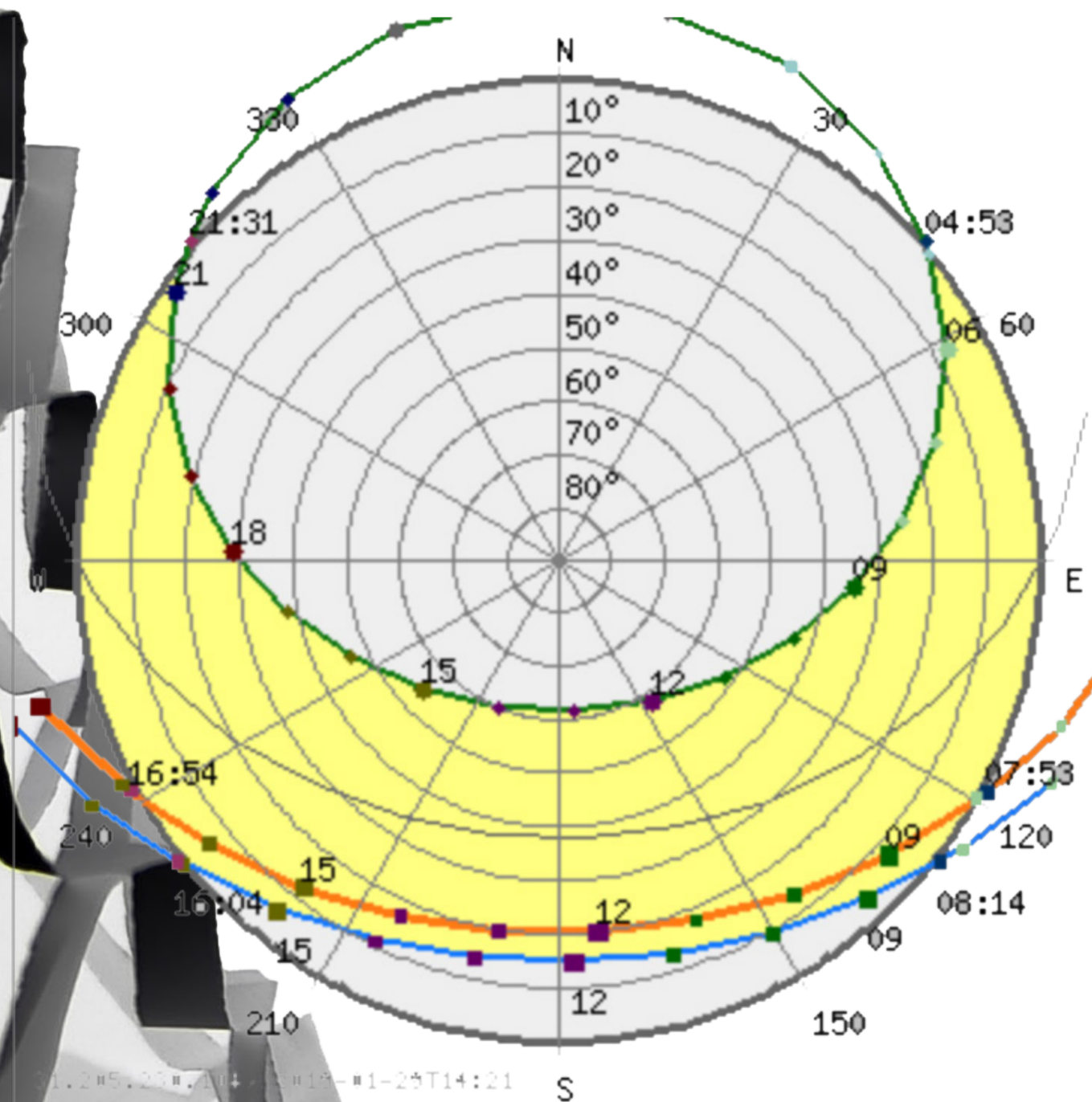

SUN PATH ANALYSIS

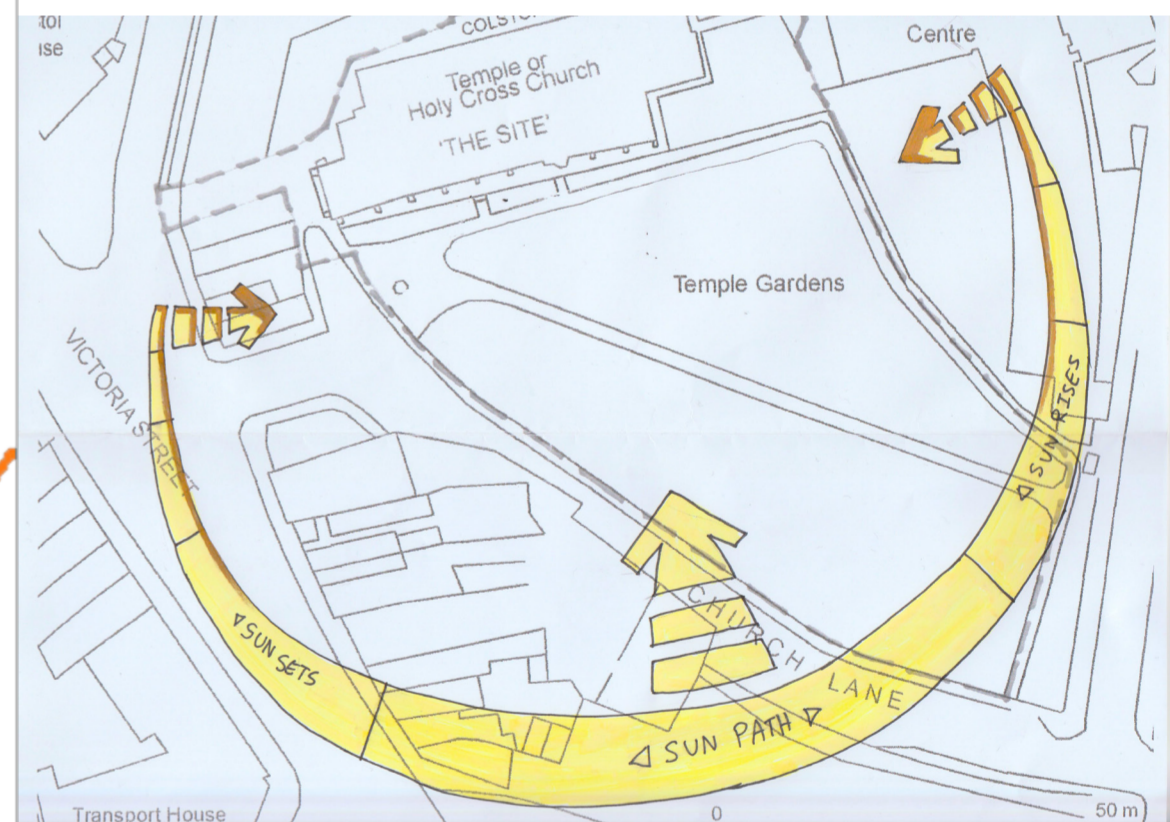

MODULAR FORM



PAVILION

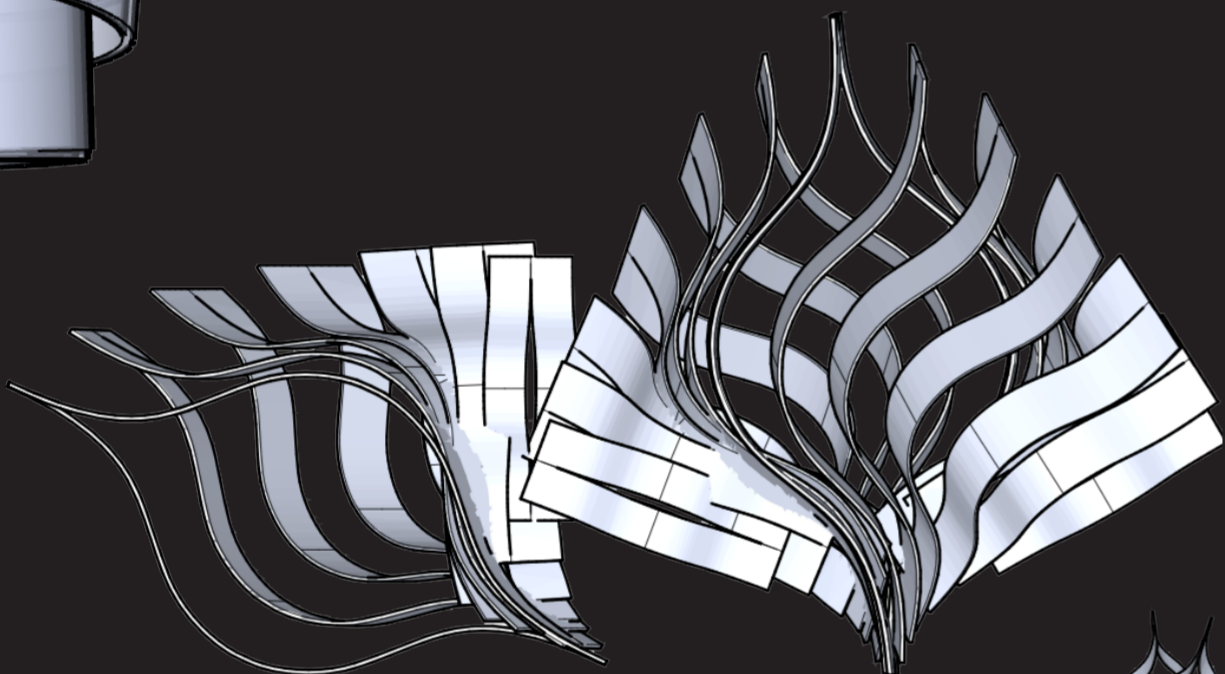
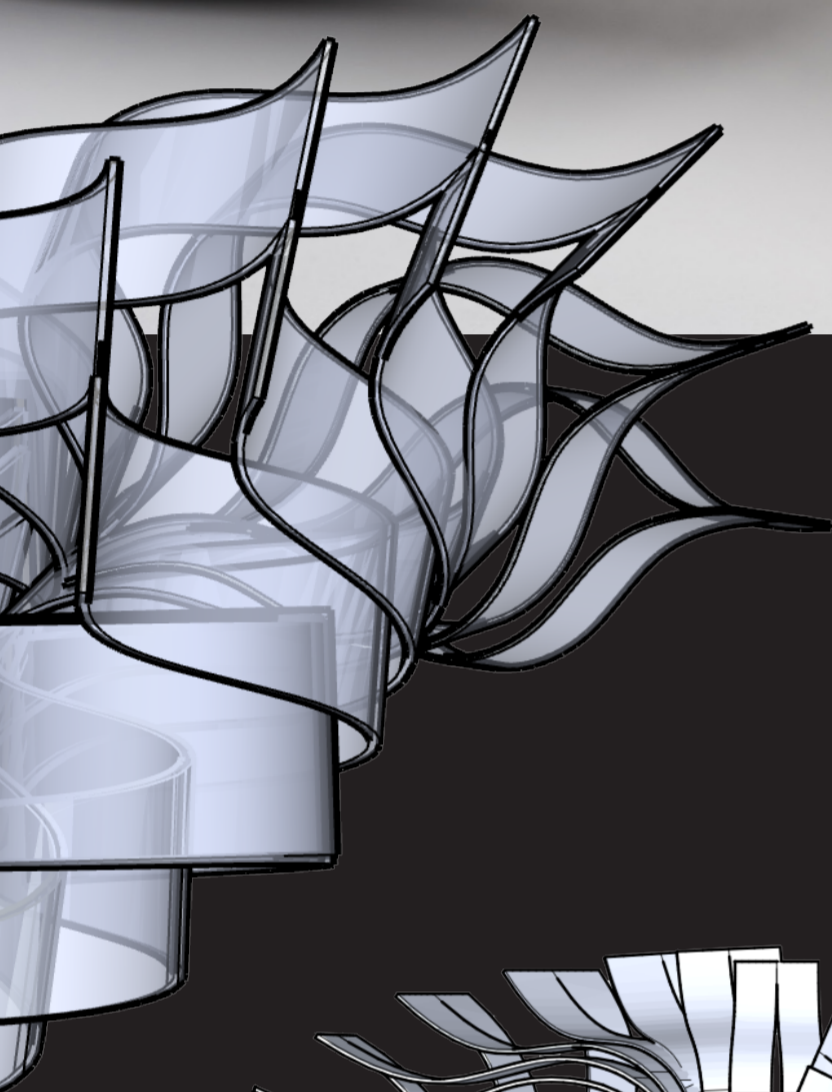

LEFT ELEVATION

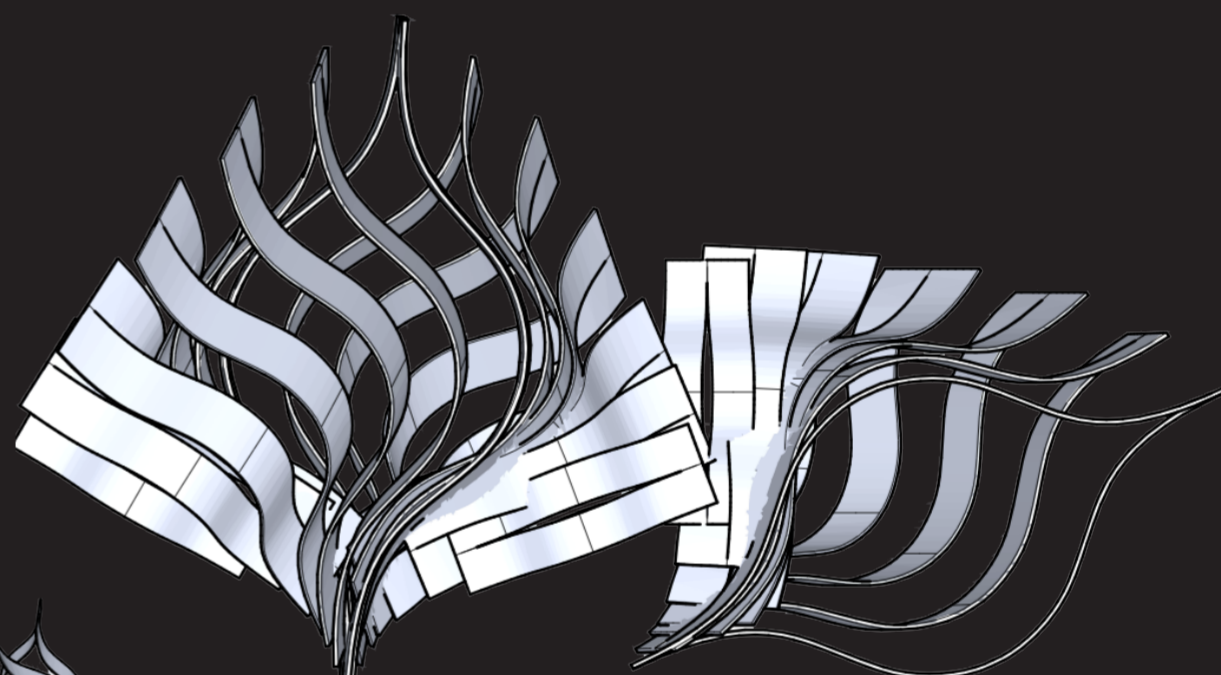

RIGHT ELEVATION



PLAN

MATERIAL

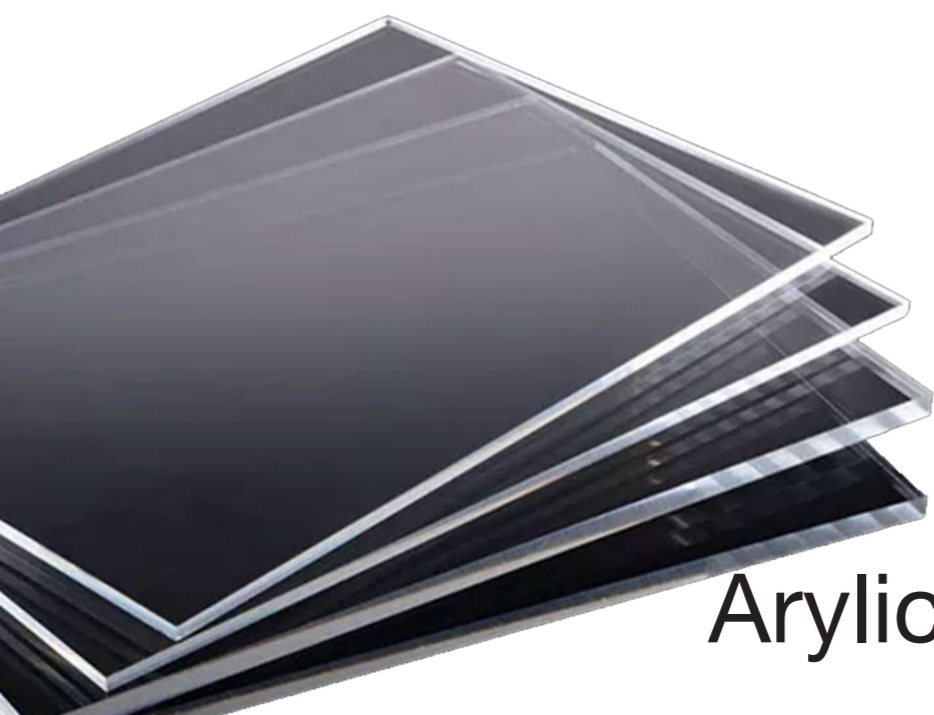

Acrylic Sheets



Metal Rod

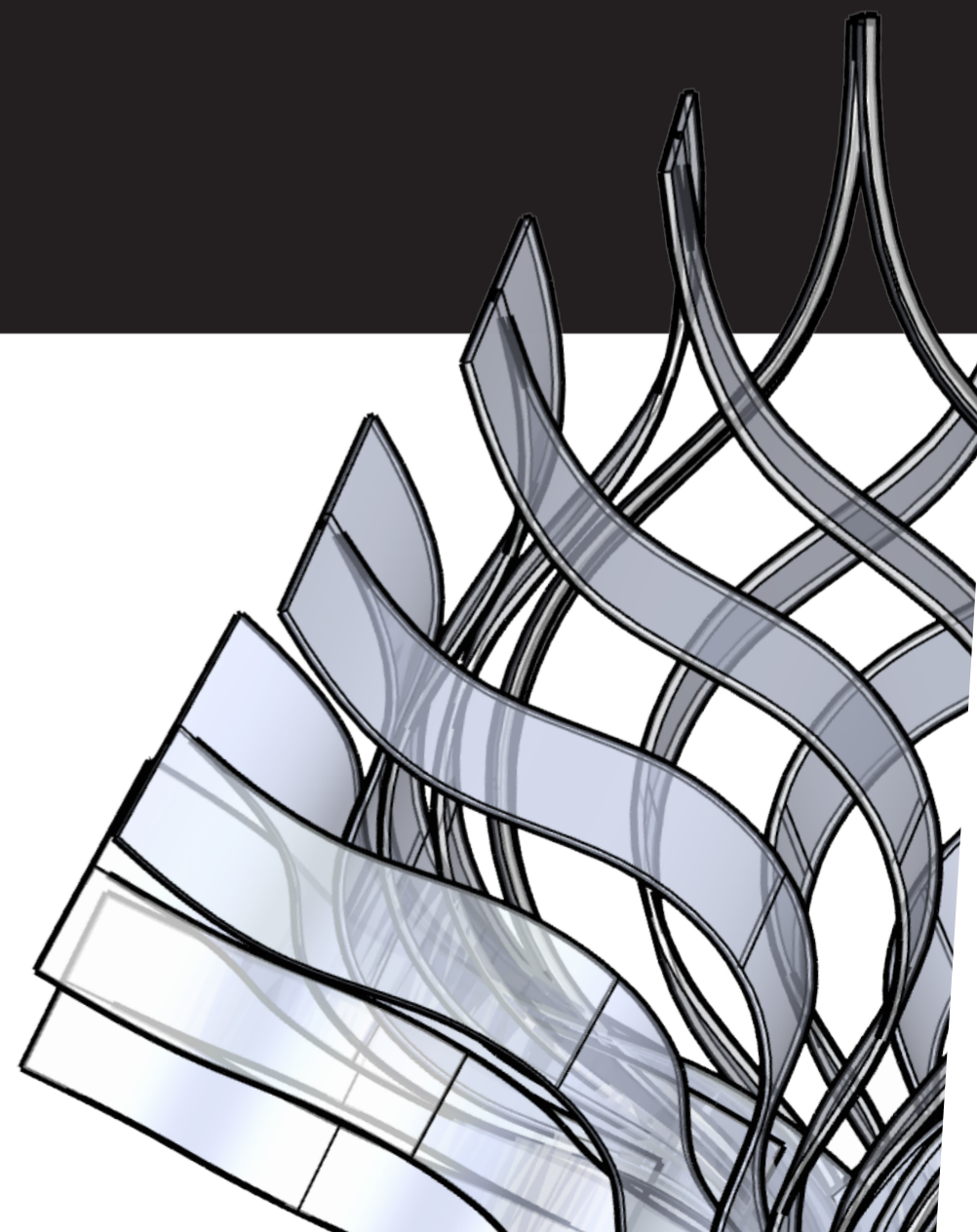

BAR DESIGN



PLAN

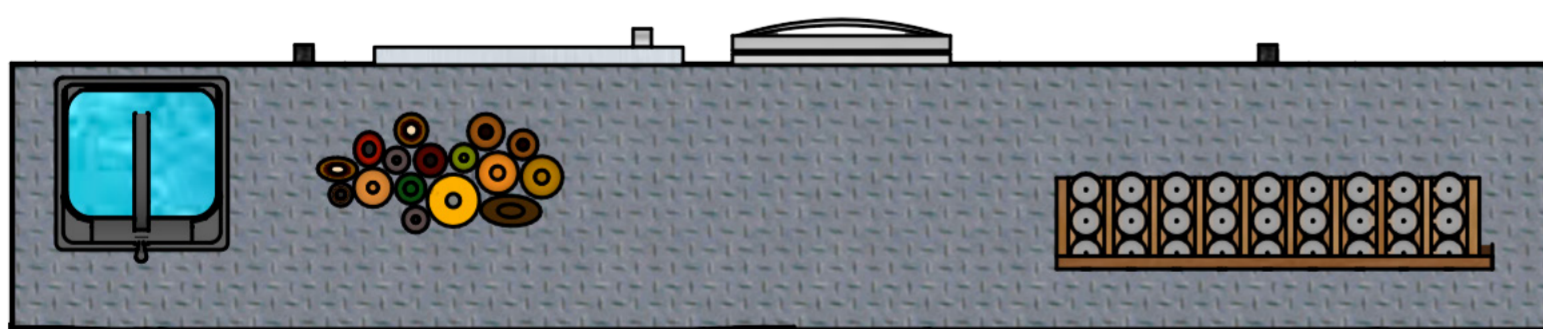

FRONT ELEVATION

My main bar uses the same curve from the modular form to form a new design, and for the back bar I just use the modular form and duplicate it 9 times to create the design



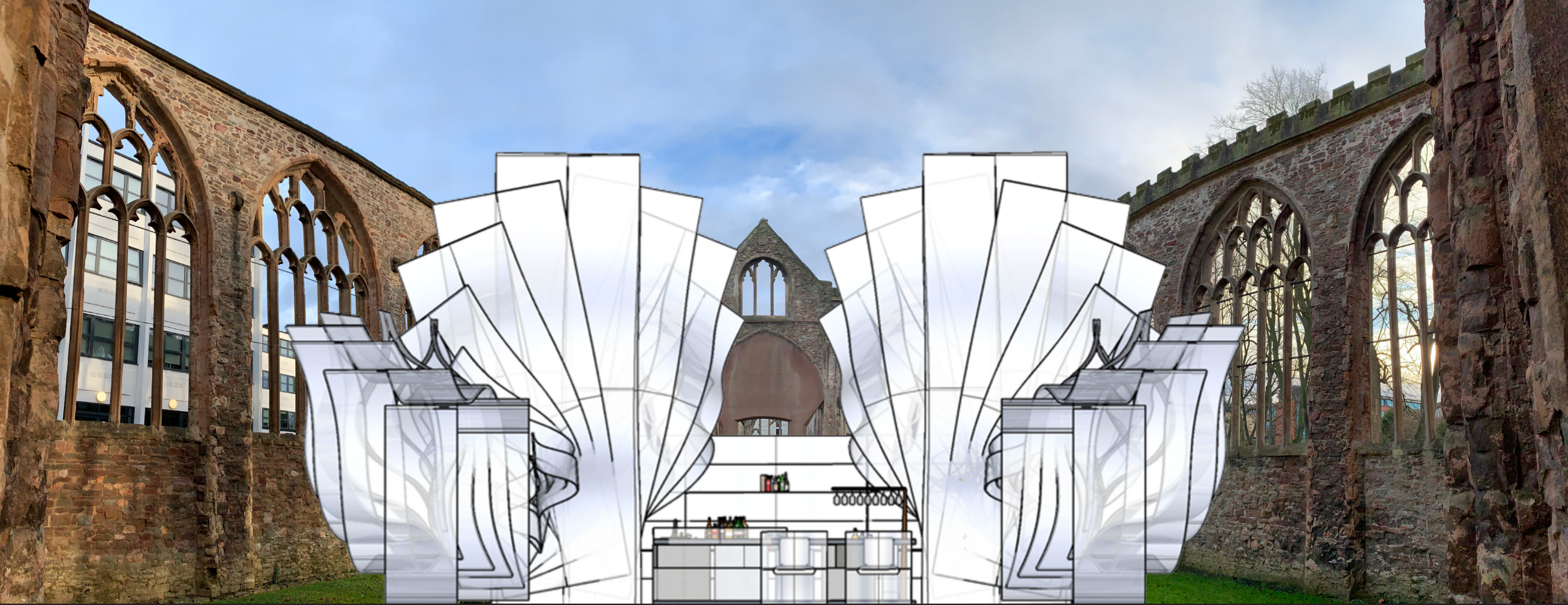

FINAL

